



FLAT S

Lavov architectural luminaire from the family FLAT S with a power of 48W and a beam angle of 90°. UGR19. Finished in grey colour. With a total lumen output of 4800lm and a luminous efficacy of 100lm/W. Made in Aluminium housing and PC microprismatic diffuser. Driver 1-10V dimmable TUYA app control. CCT 3000K.

Dimensions

Product dimensions (mm) 600*450*55mm

Scheme

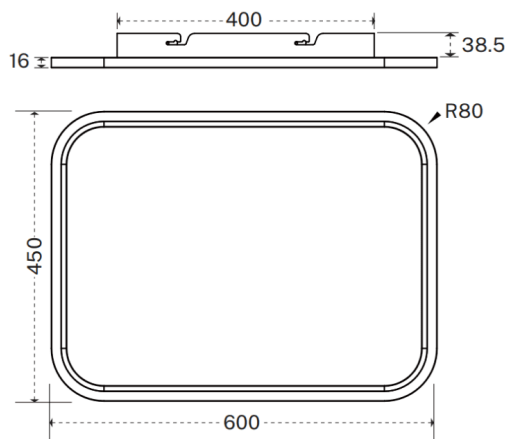

Item code	86.A0012.1392.03
Product type	Indoor
Category	Architectural luminaires
Family	FLAT
Subfamily	FLAT S
Pictograms	

Product	
Real power (W)	48
Real luminous flux (Lm)	4800
Luminous efficiency (Lm/W)	100
Beam angle (º)	90°
Colour	grey
U. G. R	<19
Control gear included	yes
Control gear	1-10V dimmable TUYA app control
Power Factor	>0.9
Flicker Free	yes
Average life time (h)	L80 B20, 50,000hrs
Colour temperature (K)	3000
Colour consistency (SDCM)	SDCM<3
CRI	80