



FLYING R

Lavov architectural luminaire from the family FLYING R with a power of 25W and an optics 90 degrees beam angle with UGR19. CCT 4000K. With a total lumen output of 2500lm and an efficacy of 100lm/W . Made in Aluminium housing and PC diffuser and finished in grey color. DALI driver.

Dimensions

Product dimensions (mm) diam 300x91 mm

Scheme

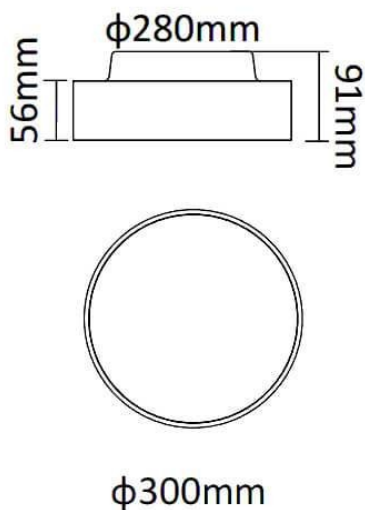

Item code	86.A007.1433.03
Product type	Indoor
Category	Architectural luminaires
Family	FLYING
Subfamily	FLYING R
Pictograms	

Product	
Real power (W)	25
Real luminous flux (Lm)	2500
Luminous efficiency (Lm/W)	100
Beam angle (°)	90
Colour	grey
Chip Brand	Samsung
Control gear included	yes
Control gear	DALI
Power Factor	>0,96
Flicker Free	yes
Light source	LED
Type of LED	SMD
Average life time (h)	L80 B20, 50,000hrs
Colour temperature (K)	4000K
Colour consistency (SDCM)	SDCM4
CRI	80