



FLYING R

Lavov architectural luminaire from the family FLYING R with a power of 30W and an optics 90 degrees beam angle with UGR19. CCT 4000K. With a total lumen output of 3000lm and an efficacy of 100lm/W . Made in Aluminium housing and PC diffuser and finished in black color. DALI driver.

Dimensions

Product dimensions (mm) diam 375x91 mm

Scheme

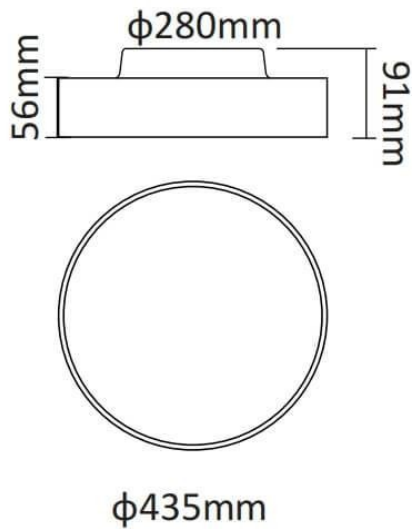

Item code	86.A007.2433.02
Product type	Indoor
Category	Architectural luminaires
Family	FLYING
Subfamily	FLYING R
Pictograms	

Product	
Real power (W)	30
Real luminous flux (Lm)	3000
Luminous efficiency (Lm/W)	100
Beam angle (º)	90
Colour	black
Chip Brand	Samsung
Control gear included	yes
Control gear	DALI
Power Factor	>0,96
Flicker Free	yes
Average life time (h)	L80 B20, 50,000hrs
Colour temperature (K)	4000K
Colour consistency (SDCM)	SDCM<4
CRI	80