



FLYING R

Lavov architectural luminaire from the family FLYING R with a power of 60W and an optics 90 degrees beam angle with UGR19. CCT 4000K. With a total lumen output of 6000lm and an efficacy of 100lm/W . Made in Aluminium housing and PC diffuser and finished in white color. ON-OFF driver.

Dimensions

Product dimensions (mm) diam 585x91mm

Scheme

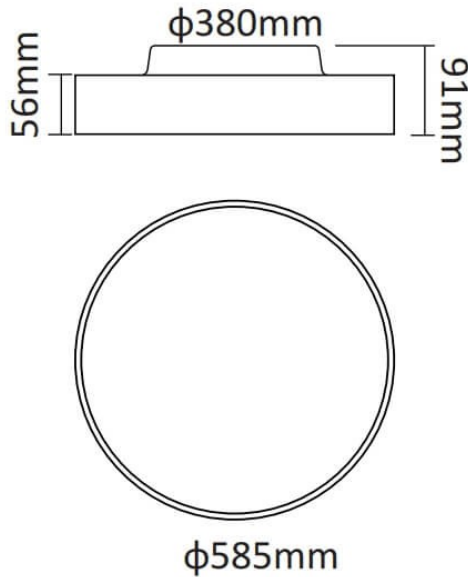

Item code	86.A007.4431.01
Product type	Indoor
Category	Architectural luminaires
Family	FLYING
Subfamily	FLYING R
Pictograms	

Product	
Real power (W)	60
Real luminous flux (Lm)	6000
Luminous efficiency (Lm/W)	100
Beam angle (°)	90
Colour	white
Chip Brand	Samsung
Control gear included	yes
Control gear	ON-OFF
Power Factor	>0,96
Flicker Free	yes
Light source	LED
Type of LED	SMD
Average life time (h)	L80 B20, 50,000hrs
Colour temperature (K)	4000K
Colour consistency (SDCM)	SDCM4
CRI	80