



FLYING R

Lavov architectural luminaire from the family FLYING R with a power of 80W and an optics 90 degrees beam angle with UGR

Item code	86.A007.5331.02
Product type	Indoor
Category	Architectural luminaires
Family	FLYING
Subfamily	FLYING R

Pictograms

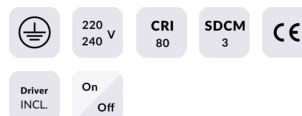

Product

Real power (W)	80
Real luminous flux (Lm)	8000
Luminous efficiency (Lm/W)	100
Beam angle (°)	90
Colour	black
Chip Brand	Samsung
Control gear included	yes
Control gear	ON-OFF
Power Factor	>0,96
Flicker Free	yes
Average life time (h)	L80 B20, 50,000hrs
Colour temperature (K)	3000K
Colour consistency (SDCM)	SDCM<4
CRI	80

Dimensions

Product dimensions (mm) **diam 735x91 mm**

Scheme

