



D-TUBE2

Lavov Downlights from the family D-TUBE2 ,power 60 W and CRI 80 with an optic 40 degrees made in Die Cast Aluminum finished in White with a real lumen output of 4860lm and an efficiency of 81lm/W. DALI driver.

Item code	86.D011.2333.01
Product type	Indoor
Category	Downlights
Family	D-TUBE
Subfamily	D-TUBE2
Pictograms	

Scheme

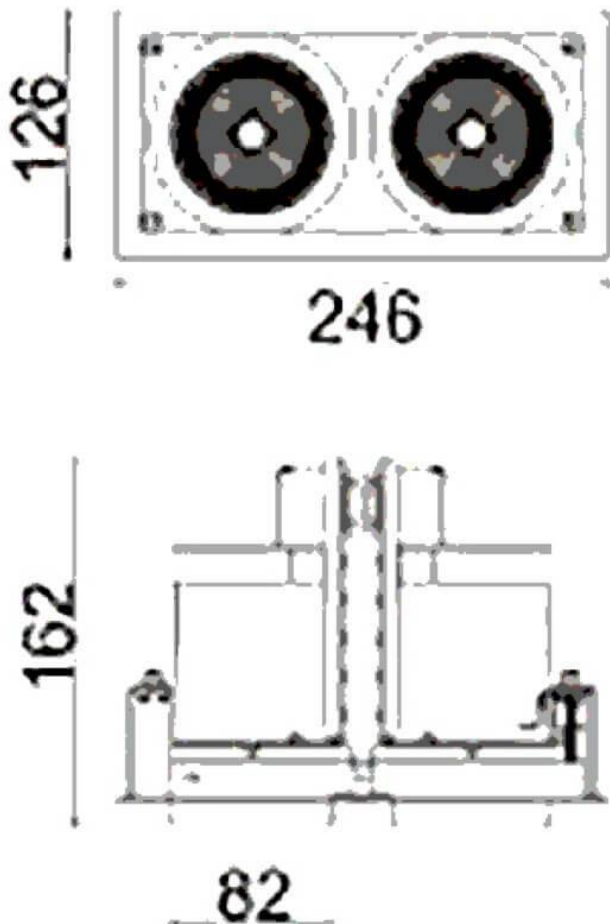

Product	
Real power (W)	60
Real luminous flux (Lm)	4860
Luminous efficiency (Lm/W)	81
Beam angle (°)	40
Life time (h)	50000 h L80B10
IP	20
Electrical class insulation	Clas II
Colour	White
Control gear included	Yes
Control gear	DALI
Flicker Free	Yes
Light source	LED
Type of LED	COB
Colour temperature (K)	3000
Colour consistency (SDCM)	SDCM<3
CRI	80