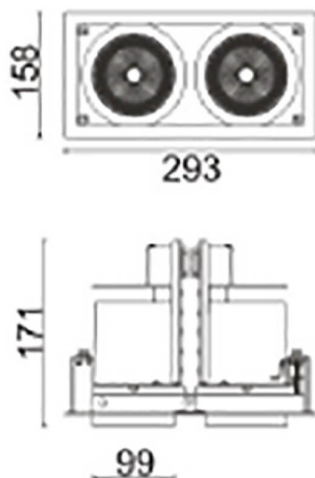

**D-TUBE2**

Lavov Downlights from the family D-TUBE2 ,power 70 W and CRI 80 with an optic 12 degrees made in Die Cast Aluminum finished in Black with a real lumen output of 6080lm and an efficiency of 86,85lm/W. ON/OFF driver.

Item code	86.D011.3311.02
Product type	Indoor
Category	Downlights
Family	D-TUBE
Subfamily	D-TUBE2
Pictograms	

Scheme

Product	
Real power (W)	70
Real luminous flux (Lm)	6080
Luminous efficiency (Lm/W)	86.857142857143003
Beam angle (°)	12
Life time (h)	50000 h L80B10
IP	20
Electrical class insulation	Clas II
Colour	Black
Control gear included	Yes
Control gear	ON/OFF
Flicker Free	Yes
Light source	LED
Type of LED	COB
Colour temperature (K)	3000
Colour consistency (SDCM)	SDCM<3
CRI	80