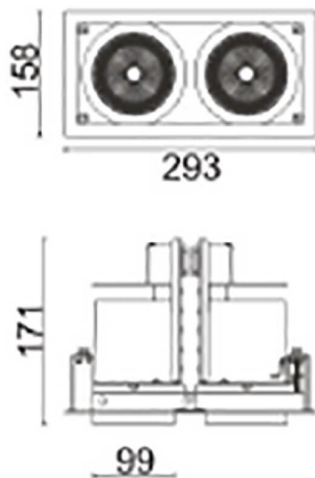

**D-TUBE2**

Lavov Downlights from the family D-TUBE2 ,power 70 W and CRI 80 with an optic 24 degrees made in Die Cast Aluminum finished in Black with a real lumen output of 6140lm and an efficiency of 87,71lm/W. ON/OFF driver.

|              |   |
|--------------|---|
| Item code    | 86.D011.3421.02   |
| Product type | Indoor  |
| Category     | Downlights  |
| Family       | D-TUBE  |
| Subfamily    | D-TUBE2   |
| Pictograms   |  |

**Scheme**

|                             |                    |
|-----------------------------|--------------------|
| <b>Product</b>              |                    |
| Real power (W)              | 70                 |
| Real luminous flux (Lm)     | 6140               |
| Luminous efficiency (Lm/W)  | 87.714285714286007 |
| Beam angle (°)              | 24                 |
| Life time (h)               | 50000 h L80B10     |
| IP                          | 20                 |
| Electrical class insulation | Clas II            |
| Colour                      | Black              |
| Control gear included       | Yes                |
| Control gear                | ON/OFF             |
| Flicker Free                | Yes                |
| Light source                | LED                |
| Type of LED                 | COB                |
| Colour temperature (K)      | 4000               |
| Colour consistency (SDCM)   | SDCM<3             |
| CRI                         | 80                 |