



D-TUBE2

Lavov Downlights from the family D-TUBE2 ,power 70 W and CRI 80 with an optic 40 degrees made in Die Cast Aluminum finished in White with a real lumen output of 6140lm and an efficiency of 87,71lm/W. ON/OFF driver.

Item code	86.D011.3431.01
Product type	Indoor
Category	Downlights
Family	D-TUBE
Subfamily	D-TUBE2
Pictograms	

Scheme

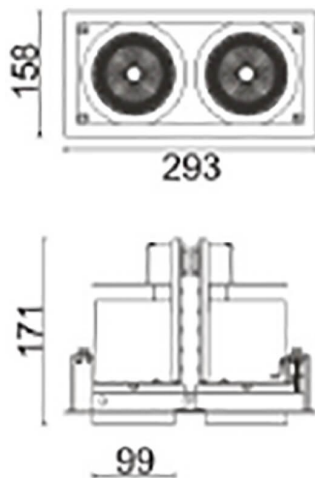

Product	
Real power (W)	70
Real luminous flux (Lm)	6140
Luminous efficiency (Lm/W)	87.714285714286007
Beam angle (°)	40
Life time (h)	50000 h L80B10
IP	20
Electrical class insulation	Clas II
Colour	White
Control gear included	Yes
Control gear	ON/OFF
Flicker Free	Yes
Light source	LED
Type of LED	COB
Colour temperature (K)	4000
Colour consistency (SDCM)	SDCM<3
CRI	80