



D-TUBE3

Lavov Downlights from the family D-TUBE3 ,power 90 W and CRI 80 with an optic 12 degrees made in Die Cast Aluminum finished in Black with a real lumen output of 7410lm and an efficiency of 82,33lm/W. DALI driver.

Item code	86.D012.2413.02
Product type	Indoor
Category	Downlights
Family	D-TUBE
Subfamily	D-TUBE3
Pictograms	

Scheme

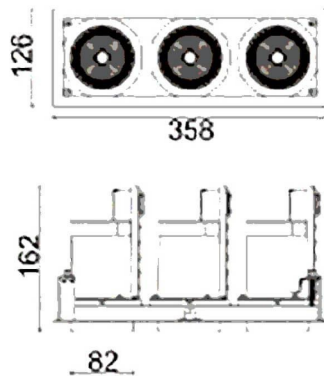

Product	
Real power (W)	90
Real luminous flux (Lm)	7410
Luminous efficiency (Lm/W)	82.333333333333002
Beam angle (°)	12
Life time (h)	50000 h L80B10
IP	20
Electrical class insulation	Clas II
Colour	Black
Control gear included	Yes
Control gear	DALI
Flicker Free	Yes
Light source	LED
Type of LED	COB
Colour temperature (K)	4000
Colour consistency (SDCM)	SDCM<3
CRI	80