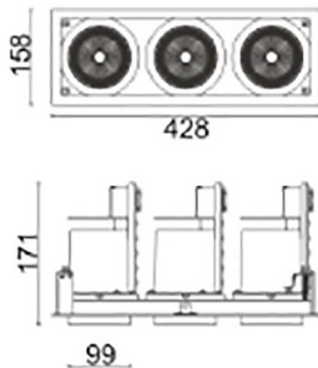

**D-TUBE3**

Lavov Downlights from the family D-TUBE3 ,power 105 W and CRI 80 with an optic 12 degrees made in Die Cast Aluminum finished in Black with a real lumen output of 9210lm and an efficiency of 87,71lm/W. DALI driver.

Item code	86.D012.3413.02
Product type	Indoor
Category	Downlights
Family	D-TUBE
Subfamily	D-TUBE3
Pictograms	

Scheme

Product	
Real power (W)	105
Real luminous flux (Lm)	9210
Luminous efficiency (Lm/W)	87.714285714286007
Beam angle (°)	12
Life time (h)	50000 h L80B10
IP	20
Electrical class insulation	Clas II
Colour	Black
Control gear included	Yes
Control gear	DALI
Flicker Free	Yes
Light source	LED
Type of LED	COB
Colour temperature (K)	4000
Colour consistency (SDCM)	SDCM<3
CRI	80