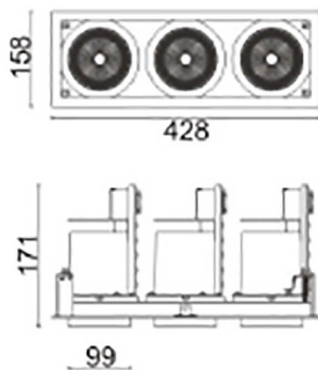

**D-TUBE3**

Lavov Downlights from the family D-TUBE3 ,power 105 W and CRI 80 with an optic 40 degrees made in Die Cast Aluminum finished in Black with a real lumen output of 9210lm and an efficiency of 87,71lm/W. ON/OFF driver.

| | |
|---------------------|---|
| Item code | 86.D012.3431.02 |
| Product type | Indoor |
| Category | Downlights |
| Family | D-TUBE |
| Subfamily | D-TUBE3 |
| Pictograms |  |

Scheme

| | |
|------------------------------------|---------------------------|
| Product | |
| Real power (W) | 105 |
| Real luminous flux (Lm) | 9210 |
| Luminous efficiency (Lm/W) | 87.714285714286007 |
| Beam angle (°) | 40 |
| Life time (h) | 50000 h L80B10 |
| IP | 20 |
| Electrical class insulation | Clas II |
| Colour | Black |
| Control gear included | Yes |
| Control gear | ON/OFF |
| Flicker Free | Yes |
| Light source | LED |
| Type of LED | COB |
| Colour temperature (K) | 4000 |
| Colour consistency (SDCM) | SDCM<3 |
| CRI | 80 |