



### PERFORM-R

Lavov Downlights from the family PERFORM-R ,power 7 W and CRI 80 with an optic 80 degrees made in Die Cast Aluminum finished in White with a real lumen output of 700lm and an efficiency of 100lm/W. DALI driver.

Item code	86.D022.1303.01
Product type	Indoor
Category	Downlights
Family	PERFORM
Subfamily	PERFORM-R
Pictograms	

### Scheme

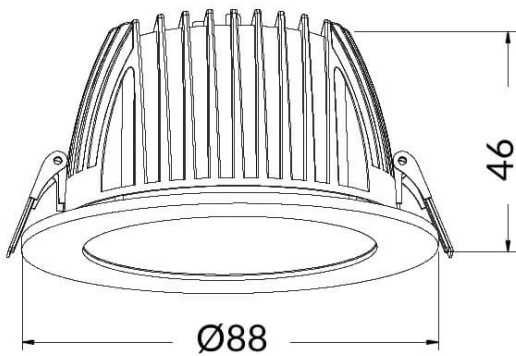

Product	
Real power (W)	7
Real luminous flux (Lm)	700
Luminous efficiency (Lm/W)	100
Beam angle (°)	80
Life time (h)	50000 h L80B10
IP	20
Electrical class insulation	Clas II
Colour	White
Control gear included	Yes
Control gear	DALI
Flicker Free	Yes
Light source	LED
Type of LED	SMD
Colour temperature (K)	3000
Colour consistency (SDCM)	SDCM3
CRI	80