

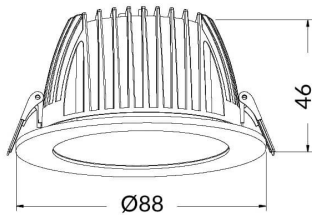

**PERFORM-R**

Lavov Downlights from the family PERFORM-R ,power 7 W and CRI 80 with an optic 80 degrees made in Die Cast Aluminum finished in White with a real lumen output of 700lm and an efficiency of 100lm/W. DALI driver.

<b>Item code</b>	<b>86.D022.1403.01</b>
<b>Product type</b>	<b>Indoor</b>
<b>Category</b>	<b>Downlights</b>
<b>Family</b>	<b>PERFORM</b>
<b>Subfamily</b>	<b>PERFORM-R</b>
<b>Pictograms</b>	

**Scheme**

<b>Product</b>	
<b>Real power (W)</b>	<b>7</b>
<b>Real luminous flux (Lm)</b>	<b>700</b>
<b>Luminous efficiency (Lm/W)</b>	<b>100</b>
<b>Beam angle (°)</b>	<b>80</b>
<b>Life time (h)</b>	<b>50000 h L80B10</b>
<b>IP</b>	<b>20</b>
<b>Electrical class insulation</b>	<b>Clas II</b>
<b>Colour</b>	<b>White</b>
<b>Control gear included</b>	<b>Yes</b>
<b>Control gear</b>	<b>DALI</b>
<b>Flicker Free</b>	<b>Yes</b>
<b>Light source</b>	<b>LED</b>
<b>Type of LED</b>	<b>SMD</b>
<b>Colour temperature (K)</b>	<b>4000</b>
<b>Colour consistency (SDCM)</b>	<b>SDCM&lt;3</b>
<b>CRI</b>	<b>80</b>