

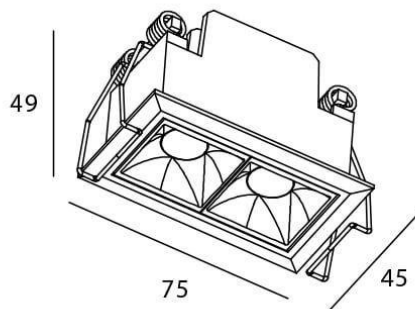

### Star

Lavov downlight from the family STAR with a power of 4W and an optics 30 degrees . CCT 4000K. With a total lumen output of 280lm and a luminous efficiency of 70lm/W.DALI driver. Made in die cast aluminum and finished in Black color. UGR19.

### Scheme



### Photometry

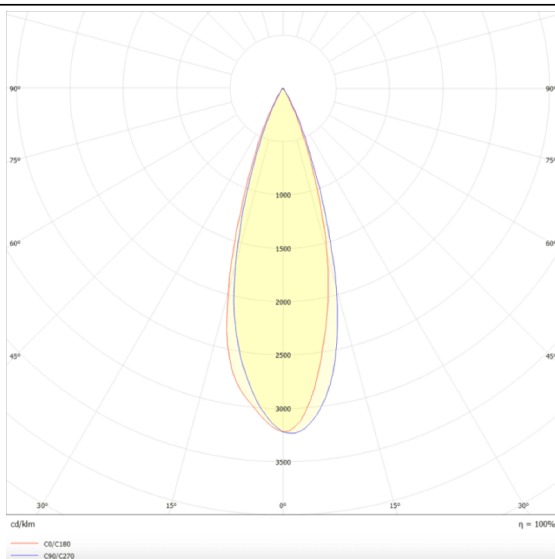

Item code	86.D029.2423.02
Product type	Indoor
Category	Downlights
Family	STAR
Subfamily	Star
Pictograms	

### Product

Real power (W)	4
Real luminous flux (Lm)	280
Luminous efficiency (Lm/W)	70
Beam angle (&ordm;)	30
Life time (h)	50000 h L80B10
IP	20
Electrical class insulation	Clas II
Colour	Black
U. G. R	UGR<19
Control gear included	Yes
Control gear	DALI
Flicker Free	Yes
Light source	LED
Type of LED	COB
Colour temperature (K)	4000
Colour consistency (SDCM)	SDCM<3
CRI	90