



Star-A

Lavov Downlights from the family Star-A ,power 2 W and CRI 90 with an optic 30 degrees made in Die Cast Aluminum finished in White with a real lumen output of 90lm and an efficiency of 45lm/W. ON/OFF driver.

Item code	86.D031.1421.01
Product type	Indoor
Category	Downlights
Family	STAR
Subfamily	Star-A

Pictograms



Scheme

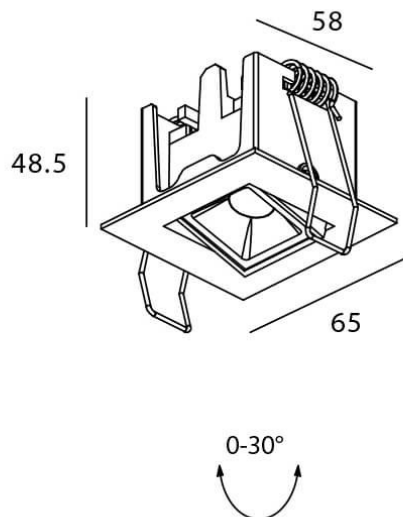

Product	
Real power (W)	2
Real luminous flux (Lm)	90
Luminous efficiency (Lm/W)	45
Beam angle (°)	30
Life time (h)	50000 h L80B10
IP	20
Electrical class insulation	Clas II
Colour	White
U. G. R	19
Control gear included	Yes
Control gear	ON/OFF
Flicker Free	Yes
Light source	LED
Type of LED	COB
Colour temperature (K)	4000
Colour consistency (SDCM)	SDCM3
CRI	90