



Star-A

Lavov Downlights from the family Star-A ,power 20 W and CRI 90 with an optic 30 degrees made in Die Cast Aluminum finished in Black with a real lumen output of 1220lm and an efficiency of 61lm/W. DALI driver.

Item code	86.D031.4323.02
Product type	Indoor
Category	Downlights
Family	STAR
Subfamily	Star-A

Pictograms



Scheme

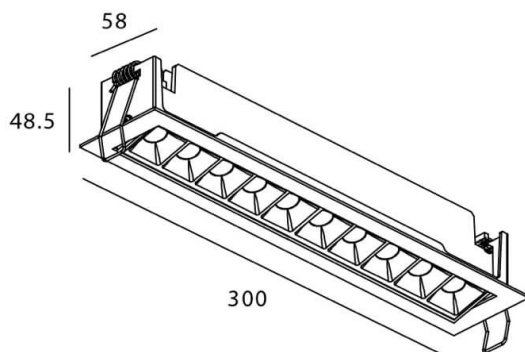

Product

Real power (W)	20
Real luminous flux (Lm)	1220
Luminous efficiency (Lm/W)	61
Beam angle (°)	30
Life time (h)	50000 h L80B10
IP	20
Electrical class insulation	Clas II
Colour	Black
U. G. R	19
Control gear included	Yes
Control gear	DALI
Flicker Free	Yes
Light source	LED
Type of LED	COB
Colour temperature (K)	3000
Colour consistency (SDCM)	SDCM3
CRI	90

Photometry

