



Star-A

Lavov Downlights from the family Star-A ,power 20 W and CRI 90 with an optic 45 degrees made in Die Cast Aluminum finished in White with a real lumen output of 1220lm and an efficiency of 61lm/W. DALI driver.

Item code 86.D031.4333.01

Product type Indoor

Category Downlights

Family STAR

Subfamily Star-A

Pictograms



Scheme



Photometry

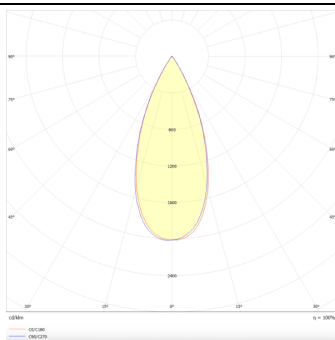

Product

Real power (W) 20

Real luminous flux (Lm) 1220

Luminous efficiency (Lm/W) 61

Beam angle (°) 45

Life time (h) 50000 h L80B10

IP 20

Electrical class insulation Clas II

Colour White

U. G. R <19

Control gear included Yes

Control gear DALI

Flicker Free Yes

Light source LED

Type of LED COB

Colour temperature (K) 3000

Colour consistency (SDCM) SDCM<3

CRI 90