



### Star-A

Lavov Downlights from the family Star-A ,power 20 W and CRI 90 with an optic 30 degrees made in Die Cast Aluminum finished in Black with a real lumen output of 1220lm and an efficiency of 61lm/W. DALI driver.

**Item code** 86.D031.4423.02

**Product type** Indoor

**Category** Downlights

**Family** STAR

**Subfamily** Star-A

**Pictograms**



### Scheme

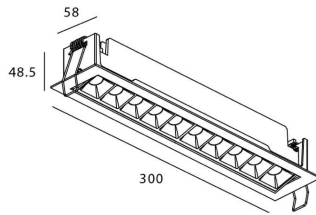

### Product

**Real power (W)** 20

**Real luminous flux (Lm)** 1220

**Luminous efficiency (Lm/W)** 61

**Beam angle (°)** 30

**Life time (h)** 50000 h L80B10

**IP** 20

**Electrical class insulation** Clas II

**Colour** Black

**U. G. R** <19

**Control gear included** Yes

**Control gear** DALI

**Flicker Free** Yes

**Light source** LED

**Type of LED** COB

**Colour temperature (K)** 4000

**Colour consistency (SDCM)** SDCM<3

**CRI** 90