



TILT

Lavov downlight from the family TILT with a power of 10W and a beam angle of 15°. Finished in White colour. With a total lumen output of 1000lm and a luminous efficacy of 100lm/W. Made in Die Cast Aluminum. Driver ON/OFF. CCT 3000K.

Item code	86.D039.1311.01
Product type	Indoor
Category	Downlights
Family	TILT

Pictograms



Scheme

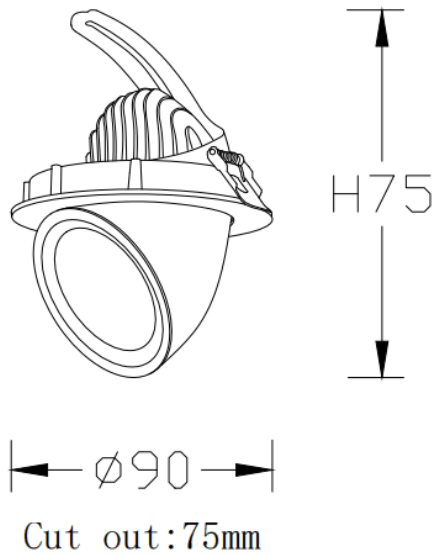

Product	
Real power (W)	10
Real luminous flux (Lm)	1000
Luminous efficiency (Lm/W)	100
Beam angle (º)	15°
Life time (h)	50000 h L80B10
IP	20
Electrical class insulation	Clas II
Colour	White
Control gear included	Yes
Control gear	ON/OFF
Flicker Free	Yes
Light source	LED
Type of LED	COB
Colour temperature (K)	3000
Colour consistency (SDCM)	SDCM<3
CRI	80