



TILT

Lavov downlight from the family TILT with a power of 25W, CRI 80 and CCT 3000K, 24 degrees beam angle. With a total lumen output of 3010lm, and a luminous efficacy of 120lm/W. Made in Die Cast Aluminum and finished in White color. ON/OFF driver.

| | |
|---------------------|------------------------|
| Item code | 86.D039.2321.01 |
| Product type | Indoor |
| Category | Downlights |
| Family | TILT |

Pictograms



Scheme

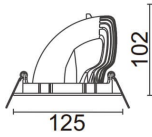

Product

| | |
|------------------------------------|-----------------------|
| Real power (W) | 25 |
| Real luminous flux (Lm) | 3010 |
| Luminous efficiency (Lm/W) | 120 |
| Beam angle (°) | 24 |
| Life time (h) | 50000 h L80B10 |
| IP | 20 |
| Electrical class insulation | Clas II |
| Colour | White |
| Control gear included | Yes |
| Control gear | ON/OFF |
| Flicker Free | Yes |
| Light source | LED |
| Type of LED | COB |
| Colour temperature (K) | 3000 |
| Colour consistency (SDCM) | SDCM<3 |
| CRI | 80 |