



TILT

Lavov downlight from the family TILT with a power of 40W, CRI 80 and CCT 3000K, 24 degrees beam angle. With a total lumen output of 4810lm, and a luminous efficacy of 120lm/W. Made in Die Cast Aluminum and finished in White color. ON/OFF driver.

Item code	86.D039.3321.01
Product type	Indoor
Category	Downlights
Family	TILT
Pictograms	

Scheme

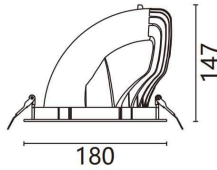

Product	
Real power (W)	40
Real luminous flux (Lm)	4810
Luminous efficiency (Lm/W)	120
Beam angle (°)	24
Life time (h)	50000 h L80B10
IP	20
Electrical class insulation	Clas II
Colour	White
Control gear included	Yes
Control gear	ON/OFF
Flicker Free	Yes
Light source	LED
Type of LED	COB
Colour temperature (K)	3000
Colour consistency (SDCM)	SDCM<3
CRI	80