



TILT

Lavov downlight from the family TILT with a power of 25W and a beam angle of 24°. Finished in White colour. With a total lumen output of 2224lm and a luminous efficacy of 97.28lm/W. Made in Die Cast Aluminum. Driver DALI. CCT 3000K.

| | |
|--------------|-----------------|
| Item code | 86.D039.3323.01 |
| Product type | Indoor |
| Category | Downlights |
| Family | TILT |
| Pictograms | |

Scheme

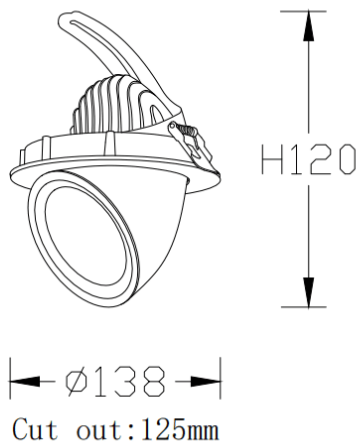

| | |
|-----------------------------|----------------|
| Product | |
| Real power (W) | 25 |
| Real luminous flux (Lm) | 2224 |
| Luminous efficiency (Lm/W) | 97.28 |
| Beam angle (º) | 24° |
| Life time (h) | 50000 h L80B10 |
| IP | 20 |
| Electrical class insulation | Clas II |
| Colour | White |
| Control gear included | Yes |
| Control gear | DALI |
| Flicker Free | Yes |
| Light source | LED |
| Type of LED | COB |
| Colour temperature (K) | 3000 |
| Colour consistency (SDCM) | SDCM<3 |
| CRI | 80 |