



### TILT

Lavov downlight from the family TILT with a power of 25W and a beam angle of 38°. Finished in White colour. With a total lumen output of 2224lm and a luminous efficacy of 97.28lm/W. Made in Die Cast Aluminum. Driver ON/OFF. CCT 4000K.

|                     |                        |
|---------------------|------------------------|
| <b>Item code</b>    | <b>86.D039.3431.01</b> |
| <b>Product type</b> | <b>Indoor</b>          |
| <b>Category</b>     | <b>Downlights</b>      |
| <b>Family</b>       | <b>TILT</b>            |
| <b>Pictograms</b>   |                        |

### Scheme

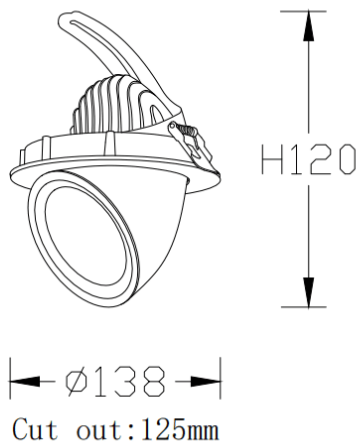

|                                    |                       |
|------------------------------------|-----------------------|
| <b>Product</b>                     |                       |
| <b>Real power (W)</b>              | <b>25</b>             |
| <b>Real luminous flux (Lm)</b>     | <b>2224</b>           |
| <b>Luminous efficiency (Lm/W)</b>  | <b>97.28</b>          |
| <b>Beam angle (&amp;ordm;)</b>     | <b>38°</b>            |
| <b>Life time (h)</b>               | <b>50000 h L80B10</b> |
| <b>IP</b>                          | <b>20</b>             |
| <b>Electrical class insulation</b> | <b>Clas II</b>        |
| <b>Colour</b>                      | <b>White</b>          |
| <b>Control gear included</b>       | <b>Yes</b>            |
| <b>Control gear</b>                | <b>ON/OFF</b>         |
| <b>Flicker Free</b>                | <b>Yes</b>            |
| <b>Light source</b>                | <b>LED</b>            |
| <b>Type of LED</b>                 | <b>COB</b>            |
| <b>Colour temperature (K)</b>      | <b>4000</b>           |
| <b>Colour consistency (SDCM)</b>   | <b>SDCM&lt;3</b>      |
| <b>CRI</b>                         | <b>80</b>             |

### Photometry

