

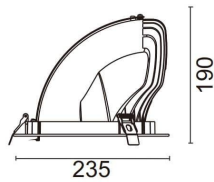

**TILT**

Lavov downlight from the family TILT with a power of 60W, CRI 80 and CCT 3000K, 24 degrees beam angle. With a total lumen output of 7210lm, and a luminous efficacy of 120lm/W. Made in Die Cast Aluminum and finished in White color. ON/OFF driver.

<b>Item code</b>	<b>86.D039.4321.01</b>
<b>Product type</b>	<b>Indoor</b>
<b>Category</b>	<b>Downlights</b>
<b>Family</b>	<b>TILT</b>

**Pictograms**

**Scheme**

<b>Product</b>	
<b>Real power (W)</b>	<b>60</b>
<b>Real luminous flux (Lm)</b>	<b>7210</b>
<b>Luminous efficiency (Lm/W)</b>	<b>120</b>
<b>Beam angle (°)</b>	<b>24</b>
<b>Life time (h)</b>	<b>50000 h L80B10</b>
<b>IP</b>	<b>20</b>
<b>Electrical class insulation</b>	<b>Clas II</b>
<b>Colour</b>	<b>White</b>
<b>Control gear included</b>	<b>Yes</b>
<b>Control gear</b>	<b>ON/OFF</b>
<b>Flicker Free</b>	<b>Yes</b>
<b>Light source</b>	<b>LED</b>
<b>Type of LED</b>	<b>COB</b>
<b>Colour temperature (K)</b>	<b>3000</b>
<b>Colour consistency (SDCM)</b>	<b>SDCM&lt;3</b>
<b>CRI</b>	<b>80</b>