



TILT

Lavov downlight from the family TILT with a power of 35W and a beam angle of 38°. Finished in White colour. With a total lumen output of 3146lm and a luminous efficacy of 91.02lm/W. Made in Die Cast Aluminum. Driver ON/OFF. CCT 4000K.

Item code	86.D039.4431.01
Product type	Indoor
Category	Downlights
Family	TILT

Pictograms



Scheme

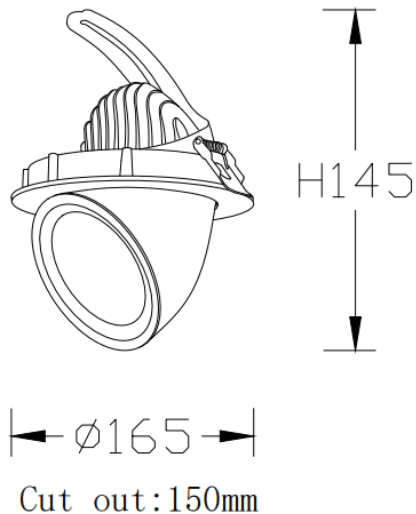

Product	
Real power (W)	35
Real luminous flux (Lm)	3146
Luminous efficiency (Lm/W)	91.02
Beam angle (°)	38°
Life time (h)	50000 h L80B10
IP	20
Electrical class insulation	Clas II
Colour	White
Control gear included	Yes
Control gear	ON/OFF
Flicker Free	Yes
Light source	LED
Type of LED	COB
Colour temperature (K)	4000
Colour consistency (SDCM)	SDCM3
CRI	80