



### TILT

Lavov downlight from the family TILT with a power of 50W and a beam angle of 15°. Finished in White colour. With a total lumen output of 4366lm and a luminous efficacy of 85.1lm/W. Made in Die Cast Aluminum. Driver DALI. CCT 4000K.

<b>Item code</b>	<b>86.D039.5413.01</b>
<b>Product type</b>	<b>Indoor</b>
<b>Category</b>	<b>Downlights</b>
<b>Family</b>	<b>TILT</b>
<b>Pictograms</b>	

### Scheme

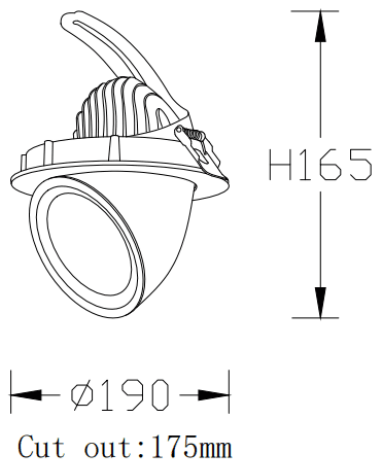

<b>Product</b>	
<b>Real power (W)</b>	<b>50</b>
<b>Real luminous flux (Lm)</b>	<b>4366</b>
<b>Luminous efficiency (Lm/W)</b>	<b>85.1</b>
<b>Beam angle (°)</b>	<b>15°</b>
<b>Life time (h)</b>	<b>50000 h L80B10</b>
<b>IP</b>	<b>20</b>
<b>Electrical class insulation</b>	<b>Clas II</b>
<b>Colour</b>	<b>White</b>
<b>Control gear included</b>	<b>Yes</b>
<b>Control gear</b>	<b>DALI</b>
<b>Flicker Free</b>	<b>Yes</b>
<b>Light source</b>	<b>LED</b>
<b>Type of LED</b>	<b>COB</b>
<b>Colour temperature (K)</b>	<b>4000</b>
<b>Colour consistency (SDCM)</b>	<b>SDCM3</b>
<b>CRI</b>	<b>80</b>