



TILT

Lavov downlight from the family TILT with a power of 50W and a beam angle of 38°. Finished in White colour. With a total lumen output of 4366lm and a luminous efficacy of 85.1lm/W. Made in Die Cast Aluminum. Driver DALI. CCT 4000K.

Item code	86.D039.5433.01
Product type	Indoor
Category	Downlights
Family	TILT
Pictograms	

Scheme

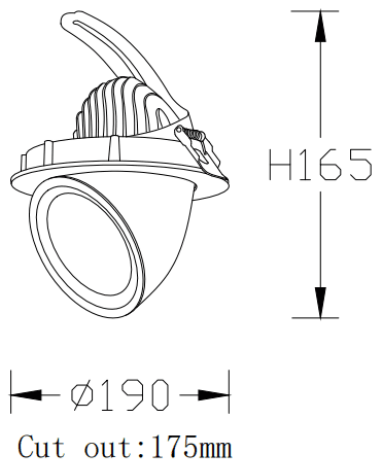

Product	
Real power (W)	50
Real luminous flux (Lm)	4366
Luminous efficiency (Lm/W)	85.1
Beam angle (°)	38°
Life time (h)	50000 h L80B10
IP	20
Electrical class insulation	Clas II
Colour	White
Control gear included	Yes
Control gear	DALI
Flicker Free	Yes
Light source	LED
Type of LED	COB
Colour temperature (K)	4000
Colour consistency (SDCM)	SDCM3
CRI	80