



GAP RT2

Lavov downlight from the family GAP RT2 with a power of 2X20W and a reflector of 36 degrees beam angle. With a total lumen output of 4000lm and an efficacy of 100lm/W. CCT 3000K. . Made in Die Cast Aluminum and finished in Black color. DALI driver.

Item code	86.D048.5333.02
Product type	Indoor
Category	Downlights
Family	GAP
Subfamily	GAP RT2
Pictograms	

Scheme

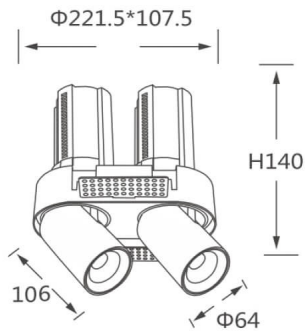

Product

Real power (W)	2X20
Real luminous flux (Lm)	4000
Luminous efficiency (Lm/W)	100
Beam angle (°)	36
Life time (h)	50000 h L80B10
Colour	Black
Control gear included	Yes
Control gear	DALI
Flicker Free	Yes
Light source	LED
Type of LED	COB
Colour temperature (K)	3000K
Colour consistency (SDCM)	SDCM<3
CRI	90