



### GAP TS3

Lavov downlight from the family GAP TS3 with a power of 3x20W and a reflector of 36 degrees beam angle. With a total lumen output of 6000lm and an efficacy of 100lm/W. CCT 4000K. . Made in Die Cast Aluminum and finished in White color. DALI driver.

<b>Item code</b>	<b>86.D055.2433.01</b>
<b>Product type</b>	<b>Indoor</b>
<b>Category</b>	<b>Downlights</b>
<b>Family</b>	<b>GAP</b>
<b>Subfamily</b>	<b>GAP TS3</b>
<b>Pictograms</b>	

### Scheme

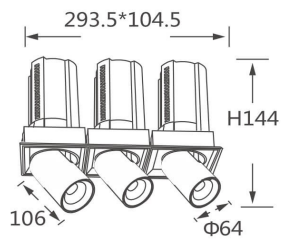

### Product

<b>Real power (W)</b>	<b>3x20</b>
<b>Real luminous flux (Lm)</b>	<b>6000</b>
<b>Luminous efficiency (Lm/W)</b>	<b>100</b>
<b>Beam angle (°)</b>	<b>36</b>
<b>Life time (h)</b>	<b>50000 h L80B10</b>
<b>Colour</b>	<b>White</b>
<b>Control gear included</b>	<b>Yes</b>
<b>Control gear</b>	<b>DALI</b>
<b>Flicker Free</b>	<b>Yes</b>
<b>Light source</b>	<b>LED</b>
<b>Type of LED</b>	<b>COB</b>
<b>Colour temperature (K)</b>	<b>4000K</b>
<b>Colour consistency (SDCM)</b>	<b>SDCM&lt;3</b>
<b>CRI</b>	<b>90</b>