

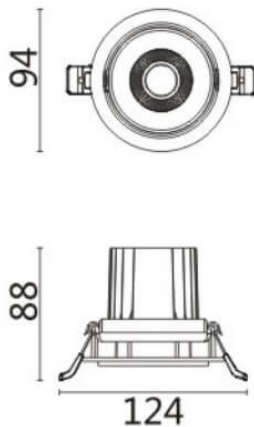



COMFORT A

Lavov downlight from the family COMFORT A with a power of 10W, CRI 80 and CCT 3000K, 12 degrees beam angle. With a total lumen output of 790lm, and a luminous efficacy of 79lm/W. Made in Die Cast Aluminum and finished in White color. ON/OFF driver.

Scheme



Item code	86.D060.1311.01
Product type	Indoor
Category	Downlights
Family	COMFORT A
Pictograms	

Product	
Real power (W)	10
Real luminous flux (Lm)	790
Luminous efficiency (Lm/W)	79
Beam angle (º)	12
Life time (h)	50000 h L80B10
IP	20
Electrical class insulation	Clas II
Colour	White
Control gear included	Yes
Control gear	ON/OFF
Flicker Free	Yes
Light source	LED
Type of LED	COB
Colour temperature (K)	3000
Colour consistency (SDCM)	SDCM<3
CRI	80