

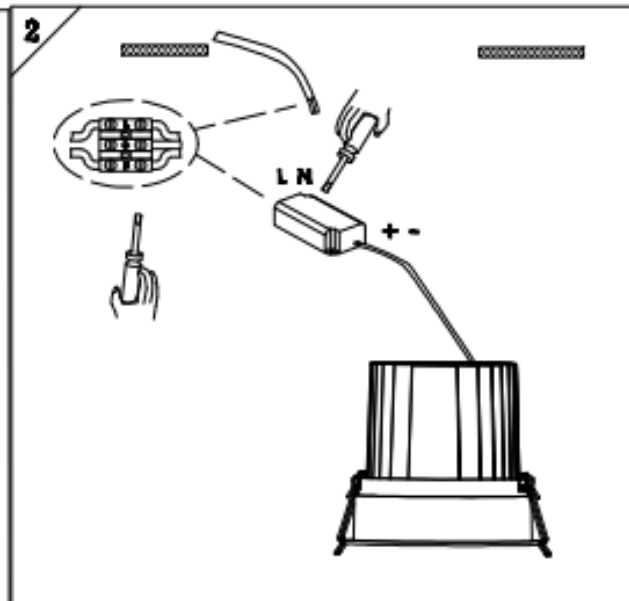

- Installation and wiring of luminaire must be in accordance with all applicable local codes.
- Installation, inspection, and maintenance of luminaires should be performed by a qualified electrician.
- DO NOT make or alter any open holes in the luminaire. Do not modify the luminaire.
- DO NOT install damaged product.
- Make sure electrical power is OFF before and during installation and maintenance.
- Make sure the equipment is properly grounded.
- Make sure the supply voltage is same as the rated fixture voltage.

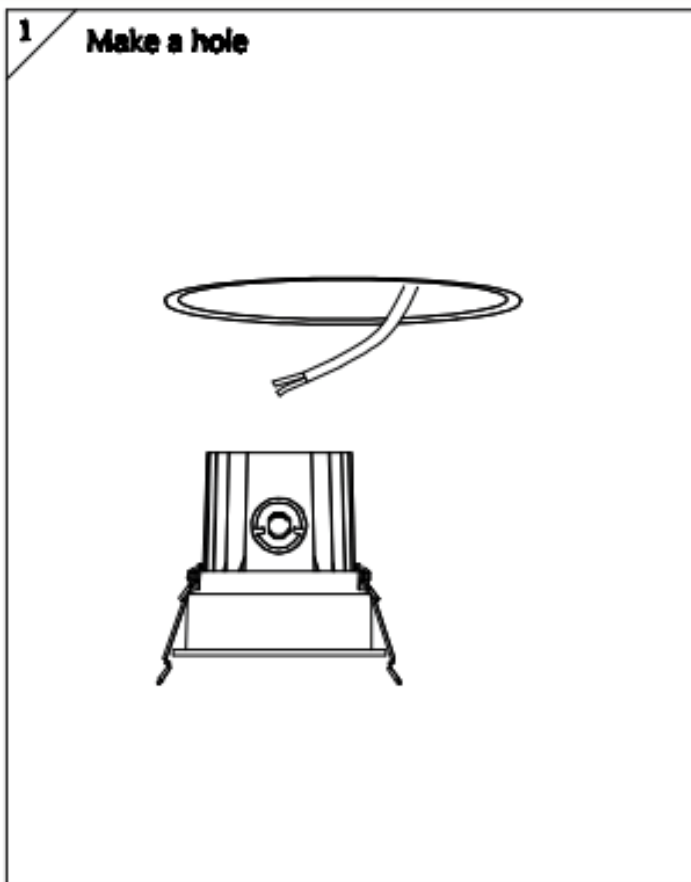

Cut out in the right size:

- 86.D060.1\*\*\*.\*\* 85mm
- 86.D060.2\*\*\*.\*\* 108mm
- 86.D060.3\*\*\*.\*\* 140mm
- 86.D060.4\*\*\*.\*\* 170mm