

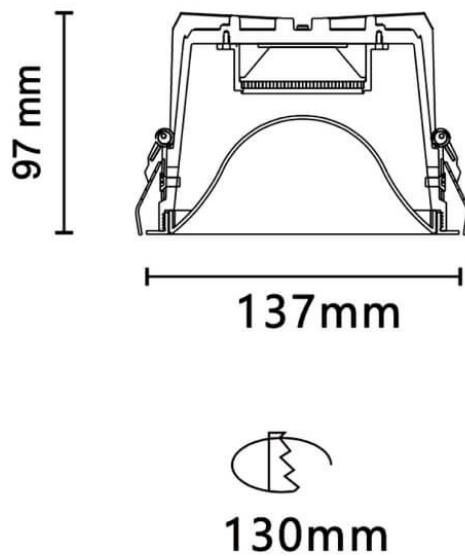

MOON

Lavov downlight from the family MOON with a power of 14.74W, CRI 90 and CCT 3000K, 80.40000000000006 degrees beam angle. With a total lumen output of 708.6992lm, and a luminous efficacy of 48.08lm/W. Made in Die Cast Aluminum and finished in Black color. DALI driver.

Scheme



Item code	86.D061.3333.02
Product type	Indoor
Category	Downlights
Family	PLANET
Subfamily	MOON
Pictograms	

Product	
Real power (W)	14.74
Real luminous flux (Lm)	708.6992
Luminous efficiency (Lm/W)	48.08
Beam angle (º)	80.4
Life time (h)	50000 h L80B10
IP	20
Electrical class insulation	Clas II
Colour	Black
Control gear included	Yes
Control gear	DALI
Flicker Free	Yes
Light source	LED
Type of LED	COB
Colour temperature (K)	3000
Colour consistency (SDCM)	SDCM<3
CRI	90