



BLUESKY

Lavov downlight from the family BLUESKY with a power of 6.62W, CRI 90 and CCT 3000K, 52.1 degrees beam angle. With a total lumen output of 523.1786lm, and a luminous efficacy of 79.03lm/W. Made in Die Cast Aluminum and finished in Black color. DALI driver.

Item code	86.D062.1333.02
Product type	Indoor
Category	Downlights
Family	PLANET
Subfamily	BLUESKY
Pictograms	

Scheme

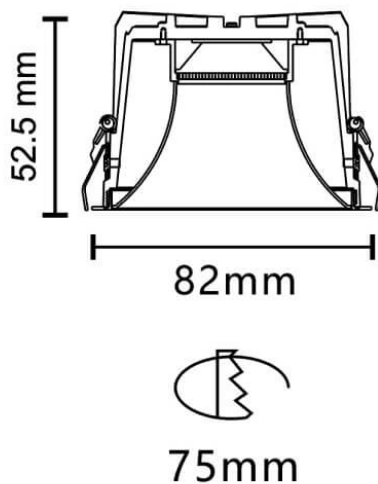

Product	
Real power (W)	6.62
Real luminous flux (Lm)	523.1785999999996
Luminous efficiency (Lm/W)	79.03
Beam angle (°)	52.1
Life time (h)	50000 h L80B10
IP	20
Electrical class insulation	Clas II
Colour	Black
Control gear included	Yes
Control gear	DALI
Flicker Free	Yes
Light source	LED
Type of LED	COB
Colour temperature (K)	3000
Colour consistency (SDCM)	SDCM3
CRI	90