

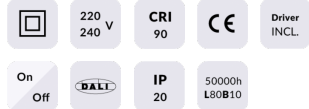

### BLUESKY

Lavov downlight from the family BLUESKY with a power of 19.420000000000002W, CRI 90 and CCT 4000K, 41.2 degrees beam angle. With a total lumen output of 1426.8lm, and a luminous efficacy of 73.47lm/W. Made in Die Cast Aluminum and finished in White color. ON/OFF driver.

Item code	86.D062.3431.01
Product type	Indoor
Category	Downlights
Family	PLANET
Subfamily	BLUESKY
Pictograms	

### Scheme

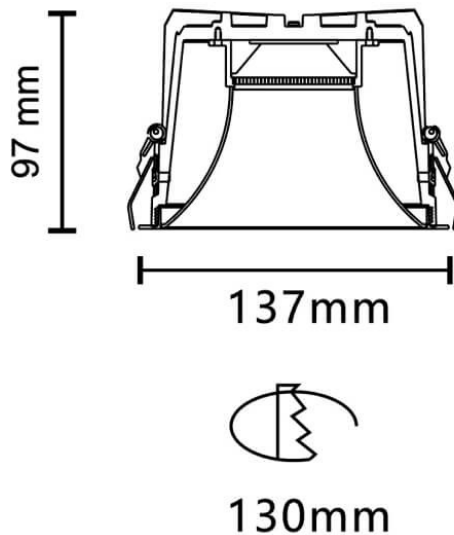

Product	
Real power (W)	19.420000000000002
Real luminous flux (Lm)	1426.8
Luminous efficiency (Lm/W)	73.47
Beam angle (°)	41.2
Life time (h)	50000 h L80B10
IP	20
Electrical class insulation	Clas II
Colour	White
Control gear included	Yes
Control gear	ON/OFF
Flicker Free	Yes
Light source	LED
Type of LED	COB
Colour temperature (K)	4000
Colour consistency (SDCM)	SDCM3
CRI	90