



BLUESKY

Lavov downlight from the family BLUESKY with a power of 19.420000000000002W, CRI 90 and CCT 4000K, 41.2 degrees beam angle. With a total lumen output of 1426.8lm, and a luminous efficacy of 73.47lm/W. Made in Die Cast Aluminum and finished in White color. DALI driver.

Item code	86.D062.3433.01
Product type	Indoor
Category	Downlights
Family	PLANET
Subfamily	BLUESKY

Pictograms

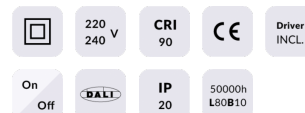

Product	
Real power (W)	19.420000000000002
Real luminous flux (Lm)	1426.8
Luminous efficiency (Lm/W)	73.47
Beam angle (°)	41.2
Life time (h)	50000 h L80B10
IP	20
Electrical class insulation	Clas II
Colour	White
Control gear included	Yes
Control gear	DALI
Flicker Free	Yes
Light source	LED
Type of LED	COB
Colour temperature (K)	4000
Colour consistency (SDCM)	SDCM3
CRI	90

Scheme

