



### MINI 6

Lavov downlight from the family MINI with a power of 6W, CRI 90 and CCT 3000K, 15 degrees beam angle. With a total lumen output of 268lm, and a luminous efficacy of 44.666666666667lm/W. Made in Die Cast Aluminum and finished in White color. DALI driver.

**Item code** 86.D072.1313.01

**Product type** Indoor

**Category** Downlights

**Family** MINI

**Subfamily** MINI 6

**Pictograms**



### Dimensions

**Product dimensions (mm)** Ø40\*H75

### Scheme

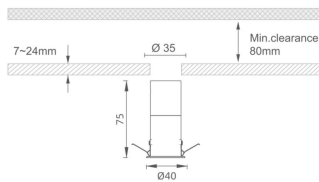

### Product

**Real power (W)** 6

**Real luminous flux (Lm)** 268

**Luminous efficiency (Lm/W)** 44.666666666667

**Beam angle (°)** 15

**Life time (h)** 50000 h L80B10

**IP** 20

**Electrical class insulation** Clas III

**Colour** White

**U. G. R** <19

**Control gear included** Yes

**Control gear** DALI

**Flicker Free** Yes

**Light source** LED

**Type of LED** SMD

**Colour temperature (K)** 3000

**Colour consistency (SDCM)** SDCM<3

**CRI** 90