



ZENITH IP65R

Lavov downlight from the family ZENITH IP65R with a power of 10W and a 36 degrees beam angle. CCT 4000K. Black color. With a total lumen output of 800lm and a luminous efficacy of 80lm/W. Made in Die Cast Aluminum. IP65 degree of protection. Class II isolation. ON/OFF driver. UGR19. CRI90.

Dimensions

Product dimensions (mm) $\Phi 62 \times 85 \text{mm}$

Scheme

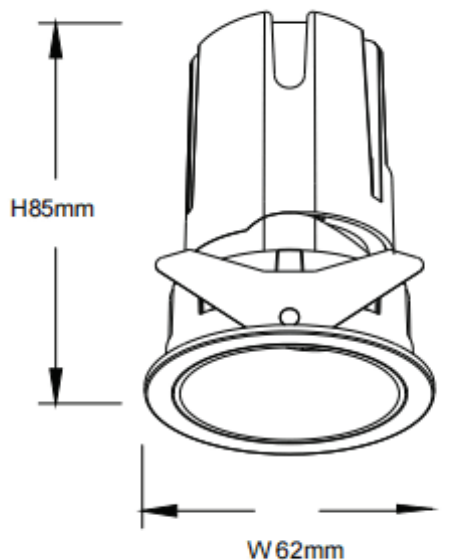

Item code	86.D084.0431.02
Product type	Indoor
Category	Downlights
Family	ZENITH
Subfamily	ZENITH IP65R
Pictograms	

Product	
Real power (W)	10
Real luminous flux (Lm)	800
Luminous efficiency (Lm/W)	80
Beam angle (º)	36
Life time (h)	50000 h L80B10
IP	65
Electrical class insulation	Clas II
Colour	Black
U. G. R	19
Control gear included	Yes
Control gear	ON/OFF
Flicker Free	Yes
Light source	LED
Type of LED	COB
Colour temperature (K)	4000
Colour consistency (SDCM)	SDCM<3
CRI	90