



### Kepler 3

Lavov downlight from the family Kepler with a power of 12W and a beam angle of 24°. Finished in white colour. With a total lumen output of 726lm and a luminous efficacy of 60,5lm/W. Made in die cast aluminium and PC lenses. Driver On-Off no dim . CCT 4000K.

<b>Item code</b>	<b>86.D099.1421.01</b>
<b>Product type</b>	<b>Indoor</b>
<b>Category</b>	<b>Downlights</b>
<b>Family</b>	<b>Kepler</b>
<b>Subfamily</b>	<b>Kepler 3</b>
<b>Pictograms</b>	

### Dimensions

**Product dimensions (mm)**      **ø62\*H59mm**

### Scheme

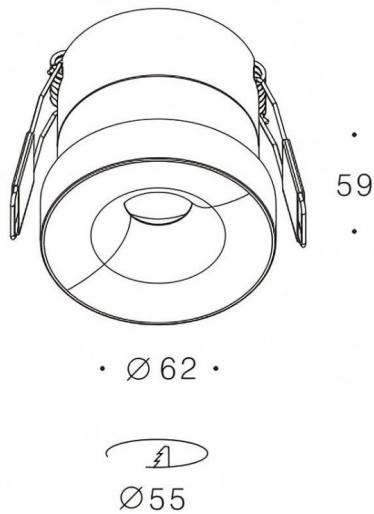

<b>Product</b>	
<b>Real power (W)</b>	<b>12</b>
<b>Real luminous flux (Lm)</b>	<b>806</b>
<b>Luminous efficiency (Lm/W)</b>	<b>67</b>
<b>Beam angle (°)</b>	<b>24°</b>
<b>Life time (h)</b>	<b>50000hrs L80B10</b>
<b>IP</b>	<b>IP44</b>
<b>Colour</b>	<b>white</b>
<b>Control gear included</b>	<b>yes</b>
<b>Control gear</b>	<b>On-Off no dim</b>
<b>Flicker Free</b>	<b>yes</b>
<b>Light source</b>	<b>led</b>
<b>Type of LED</b>	<b>COB</b>
<b>Colour temperature (K)</b>	<b>4000</b>
<b>Colour consistency (SDCM)</b>	<b>SDCM&lt;3</b>
<b>CRI</b>	<b>80</b>
<b>IK</b>	<b>06</b>

### Photometry

