



Kepler 3

Lavov downlight from the family Kepler with a power of 12W and a beam angle of 36°. Finished in matt bronze colour. With a total lumen output of 726lm and a luminous efficacy of 60,5lm/W.

Made in die cast aluminium and PC lenses. Driver Triac dimmable. CCT 4000K.

Item code	86.D099.143T.31
Product type	Indoor
Category	Downlights
Family	Kepler
Subfamily	Kepler 3
Pictograms	

Dimensions

Product dimensions (mm) **ø62*H59mm**

Scheme

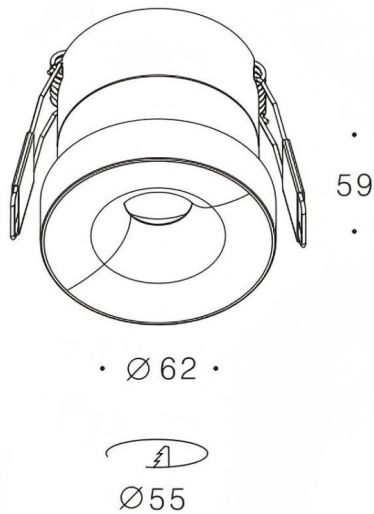

Product	
Real power (W)	12
Real luminous flux (Lm)	806
Luminous efficiency (Lm/W)	67
Beam angle (&ordm;)	36°
Life time (h)	50000hrs L80B11
IP	IP44
Colour	matt bronze
Control gear included	yes
Control gear	Triac dimmable
Flicker Free	yes
Light source	led
Type of LED	COB
Colour temperature (K)	4000
Colour consistency (SDCM)	SDCM<3
CRI	80
IK	06

Photometry

