









MINI F

Lavov downlight from the family MINI F with a power of 5W and a beam angle of 36°. Finished in White colour. Fixed version. With a total lumen output of 375lm and a luminous efficacy of 75lm/W. Made in Die Cast Aluminum. Driver DALI. CCT 2700K.

Item code	86.D102.2233.01
Product type	Indoor
Category	Downlights
Family	MINI
Subfamily	MINI F
Pictograms	     

Dimensions

Product dimensions (mm) **Ø35*H76.5mm**

Scheme

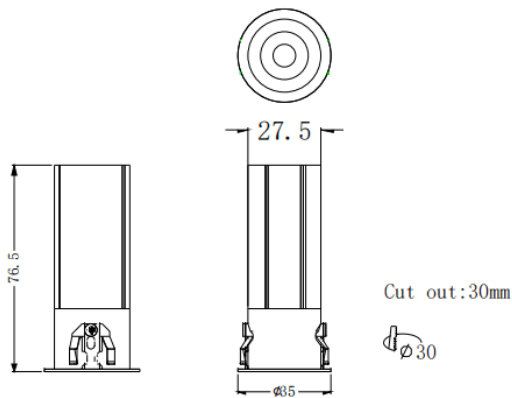

Product	
Real power (W)	5
Real luminous flux (Lm)	375
Luminous efficiency (Lm/W)	75
Beam angle (°)	36
Life time (h)	50000 h L80B10
IP	20
Electrical class insulation	Clas II
Colour	White
Control gear included	Yes
Control gear	DALI
Flicker Free	Yes
Light source	LED
Type of LED	COB
Colour temperature (K)	2700
Colour consistency (SDCM)	SDCM3
CRI	90