



### MINI F

Lavov downlight from the family MINI F with a power of 10W and a beam angle of 24°. Finished in Black colour. Fixed version. With a total lumen output of 951.6lm and a luminous efficacy of 95.16lm/W. Made in Die Cast Aluminum. Driver ON/OFF. CCT 3000K.

### Dimensions

Product dimensions (mm) **Ø55\*H103mm**

### Scheme

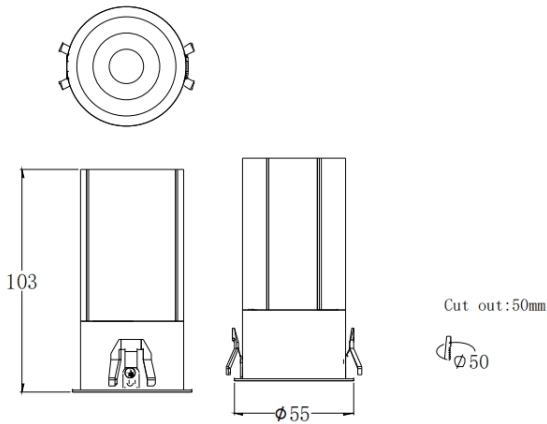

### Photometry

|              |                 |
|--------------|-----------------|
| Item code    | 86.D102.6321.02 |
| Product type | Indoor          |
| Category     | Downlights      |
| Family       | MINI            |
| Subfamily    | MINI F          |
| Pictograms   |                 |

|                             |                |
|-----------------------------|----------------|
| Product                     |                |
| Real power (W)              | 10             |
| Real luminous flux (Lm)     | 951.6          |
| Luminous efficiency (Lm/W)  | 95.16          |
| Beam angle (&ordm;)         | 24             |
| Life time (h)               | 50000 h L80B10 |
| IP                          | 20             |
| Electrical class insulation | Clas II        |
| Colour                      | Black          |
| Control gear included       | Yes            |
| Control gear                | ON/OFF         |
| Flicker Free                | Yes            |
| Light source                | LED            |
| Type of LED                 | COB            |
| Colour temperature (K)      | 3000           |
| Colour consistency (SDCM)   | SDCM<3         |
| CRI                         | 90             |

