



MINI F-T

Lavov downlight from the family MINI F-T with a power of 10W and a beam angle of 36°. Finished in White colour. Fix trimless version. With a total lumen output of 840lm and a luminous efficacy of 84lm/W. Made in Die Cast Aluminum. Driver ON/OFF. CCT 3000K.

Dimensions

Product dimensions (mm) **ø78.5*H150.5mm**

Scheme

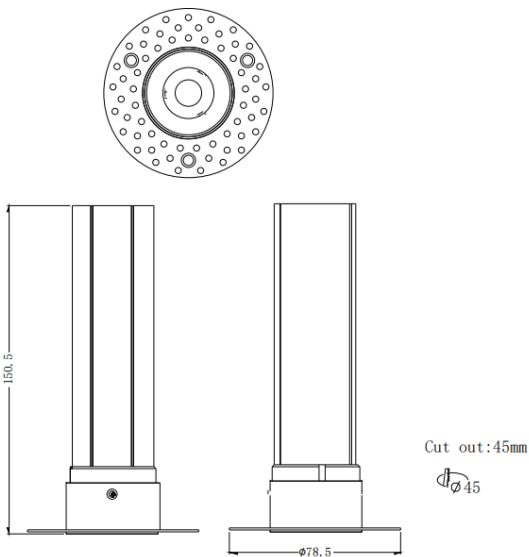

Photometry

Item code	86.D103.5331.01
Product type	Indoor
Category	Downlights
Family	MINI
Subfamily	MINI F-T
Pictograms	

Product	
Real power (W)	10
Real luminous flux (Lm)	840
Luminous efficiency (Lm/W)	84
Beam angle (°)	36
Life time (h)	50000 h L80B10
IP	20
Electrical class insulation	Clas II
Colour	White
Control gear included	Yes
Control gear	ON/OFF
Flicker Free	Yes
Light source	LED
Type of LED	COB
Colour temperature (K)	3000
Colour consistency (SDCM)	SDCM3
CRI	90

