



### MINI F-T

Lavov downlight from the family MINI F-T with a power of 10W and a beam angle of 36°. Finished in White colour. Fix trimless version. With a total lumen output of 951.6lm and a luminous efficacy of 95.16lm/W. Made in Die Cast Aluminum. Driver DALI. CCT 2700K.

### Dimensions

Product dimensions (mm) **ø88.5\*H103mm**

### Scheme

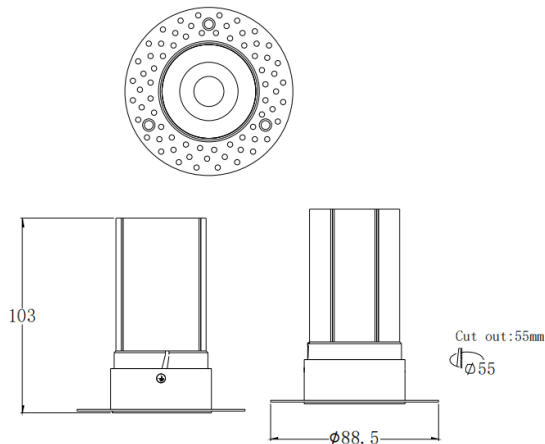

### Photometry

Item code	86.D103.6233.01
Product type	Indoor
Category	Downlights
Family	MINI
Subfamily	MINI F-T
Pictograms	

Product	
Real power (W)	10
Real luminous flux (Lm)	951.6
Luminous efficiency (Lm/W)	95.16
Beam angle (°)	36
Life time (h)	50000 h L80B10
IP	20
Electrical class insulation	Clas II
Colour	White
Control gear included	Yes
Control gear	DALI
Flicker Free	Yes
Light source	LED
Type of LED	COB
Colour temperature (K)	2700
Colour consistency (SDCM)	SDCM3
CRI	90

