



MINI F-T

Lavov downlight from the family MINI F-T with a power of 10W and a beam angle of 15°. Finished in White colour. Fix trimless version. With a total lumen output of 951.6lm and a luminous efficacy of 95.16lm/W. Made in Die Cast Aluminum. Driver ON/OFF. CCT 3000K.

Dimensions

Product dimensions (mm) **ø88.5*H103mm**

Scheme

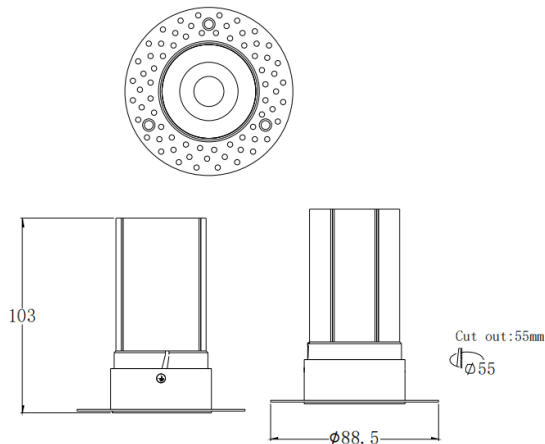

Item code	86.D103.6311.01
Product type	Indoor
Category	Downlights
Family	MINI
Subfamily	MINI F-T
Pictograms	

Product	
Real power (W)	10
Real luminous flux (Lm)	951.6
Luminous efficiency (Lm/W)	95.16
Beam angle (º)	15
Life time (h)	50000 h L80B10
IP	20
Electrical class insulation	Clas II
Colour	White
Control gear included	Yes
Control gear	ON/OFF
Flicker Free	Yes
Light source	LED
Type of LED	COB
Colour temperature (K)	3000
Colour consistency (SDCM)	SDCM<3
CRI	90