



MINI A

Lavov downlight from the family MINI A with a power of 3W and a beam angle of 36°. Finished in White colour. Adjustable version. With a total lumen output of 180lm and a luminous efficacy of 60lm/W. Made in Die Cast Aluminum. Driver ON/OFF. CCT 3000K.

Dimensions

Product dimensions (mm) **ø30*H60mm**

Scheme

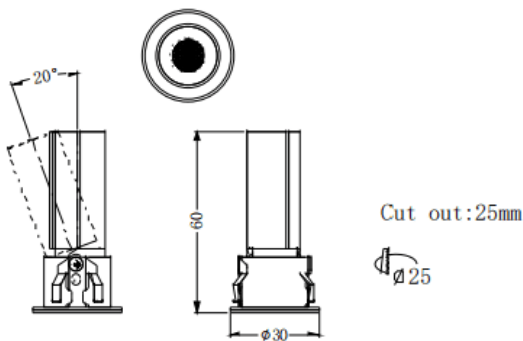

Item code	86.D104.1331.01
Product type	Indoor
Category	Downlights
Family	MINI
Subfamily	MINI A
Pictograms	

Product	
Real power (W)	3
Real luminous flux (Lm)	180
Luminous efficiency (Lm/W)	60
Beam angle (º)	36
Life time (h)	50000 h L80B10
IP	20
Electrical class insulation	Clas II
Colour	White
Control gear included	Yes
Control gear	ON/OFF
Flicker Free	Yes
Light source	LED
Type of LED	SMD
Colour temperature (K)	3000
Colour consistency (SDCM)	SDCM<3
CRI	90