



### MINI A

Lavov downlight from the family MINI A with a power of 10W and a beam angle of 36°. Finished in White colour. Adjustable version. With a total lumen output of 840lm and a luminous efficacy of 84lm/W. Made in Die Cast Aluminum. Driver DALI. CCT 3000K.

### Dimensions

Product dimensions (mm) **ø50\*H153mm**

### Scheme

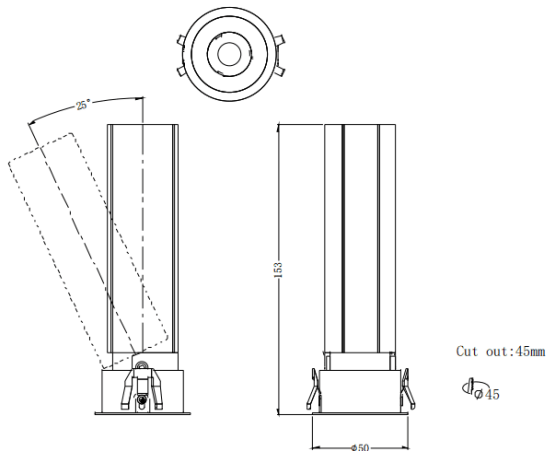

### Photometry

Item code	86.D104.5333.01
Product type	Indoor
Category	Downlights
Family	MINI
Subfamily	MINI A
Pictograms	

Product	
Real power (W)	10
Real luminous flux (Lm)	840
Luminous efficiency (Lm/W)	84
Beam angle (&ordm;)	36
Life time (h)	50000 h L80B10
IP	20
Electrical class insulation	Clas II
Colour	White
Control gear included	Yes
Control gear	DALI
Flicker Free	Yes
Light source	LED
Type of LED	COB
Colour temperature (K)	3000
Colour consistency (SDCM)	SDCM<3
CRI	90

