

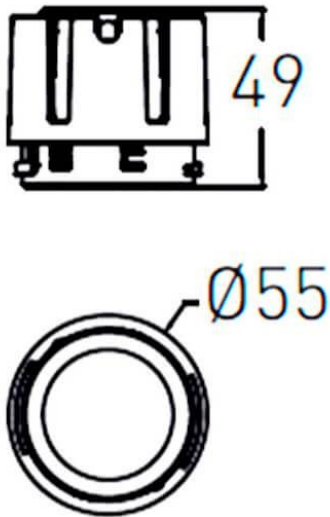

COMBO Modules

Lavov COMBO Modules ,power 9 W and CRI 90 with an optic 38 degrees made in Die Cast Aluminum finished in Silver with a real lumen output of 800lm and an efficiency of 88,89lm/W. DALI driver.

Scheme



Item code	86.D108.1333.02
Product type	Indoor
Category	Downlights
Family	COMBO
Subfamily	COMBO Modules
Pictograms	

Product	
Real power (W)	9
Real luminous flux (Lm)	800
Luminous efficiency (Lm/W)	88.89
Beam angle (º)	38
Life time (h)	50000 h L80B10
IP	20
Electrical class insulation	Clas II
Colour	Black
Control gear included	Yes
Control gear	DALI
Flicker Free	Yes
Light source	LED
Type of LED	COB
Colour temperature (K)	3000
Colour consistency (SDCM)	SDCM<3
CRI	90