

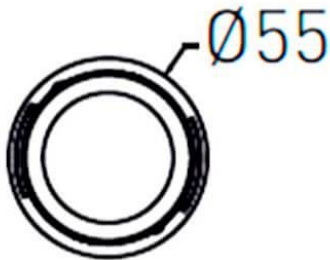

COMBO Modules

Lavov COMBO Modules ,power 9 W and CRI 90 with an optic 38 degrees made in Die Cast Aluminum finished in Silver with a real lumen output of 800lm and an efficiency of 88,89lm/W. ON/OFF driver.

Scheme

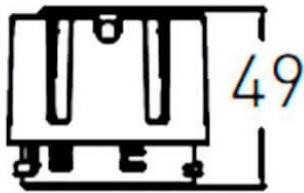

Item code	86.D108.1431.02
Product type	Indoor
Category	Downlights
Family	COMBO
Subfamily	COMBO Modules
Pictograms	

Product	
Real power (W)	9
Real luminous flux (Lm)	800
Luminous efficiency (Lm/W)	88.89
Beam angle (º)	38
Life time (h)	50000 h L80B10
IP	20
Electrical class insulation	Clas II
Colour	Black
Control gear included	Yes
Control gear	ON/OFF
Flicker Free	Yes
Light source	LED
Type of LED	COB
Colour temperature (K)	4000
Colour consistency (SDCM)	SDCM<3
CRI	90