

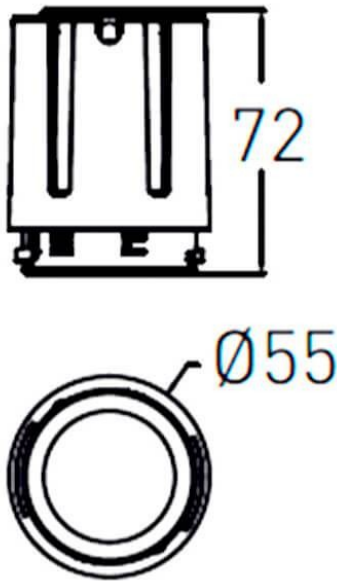

### COMBO Modules

Lavov COMBO Modules ,power 15 W and CRI 90 with an optic 38 degrees made in Die Cast Aluminum finished in Silver with a real lumen output of 2000lm and an efficiency of 90,90lm/W. ON/OFF driver.

### Scheme

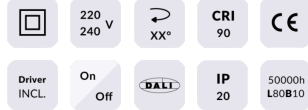

Item code	86.D108.2431.02
Product type	Indoor
Category	Downlights
Family	COMBO
Subfamily	COMBO Modules
Pictograms	

Product	
Real power (W)	15
Real luminous flux (Lm)	1500
Luminous efficiency (Lm/W)	100
Beam angle (°)	38
Life time (h)	50000 h L80B10
IP	20
Electrical class insulation	Clas II
Colour	Black
Control gear included	Yes
Control gear	ON/OFF
Flicker Free	Yes
Light source	LED
Type of LED	COB
Colour temperature (K)	4000
Colour consistency (SDCM)	SDCM3
CRI	90